

Rechargeable Party Speaker

Denver BPS-455

BASS
BOOM
POWER
COLORS
LIGHTS



Specification:

10"+10" woofer

2" tweeter

Power: 72 W RMS

USB/Micro SD Card input

Aux-in, FM Radio

Bluetooth Connect, Recording

EQ (Pop-Rock-Jazz-Classical-Flat)

TWS function: Wireless connection, up to 2pcs speakers playing together to double the sound.

Built-in 4,500 mA rechargeable battery

Play time: 1.5 hours at 100% volume

Charging time: 5-6 hours

MIC input, Guitar Input

Microphone priority

Different modes Disco light (controlled by top panel and remote control)

BASS/Treble/Microphone Volume control/Microphone Echo

Product size: 33 x 28 x 84 cm

Product weight: 11.15 kg

What you have in pack:

- User manual
- Remote control
- Power cable

Top panel operation

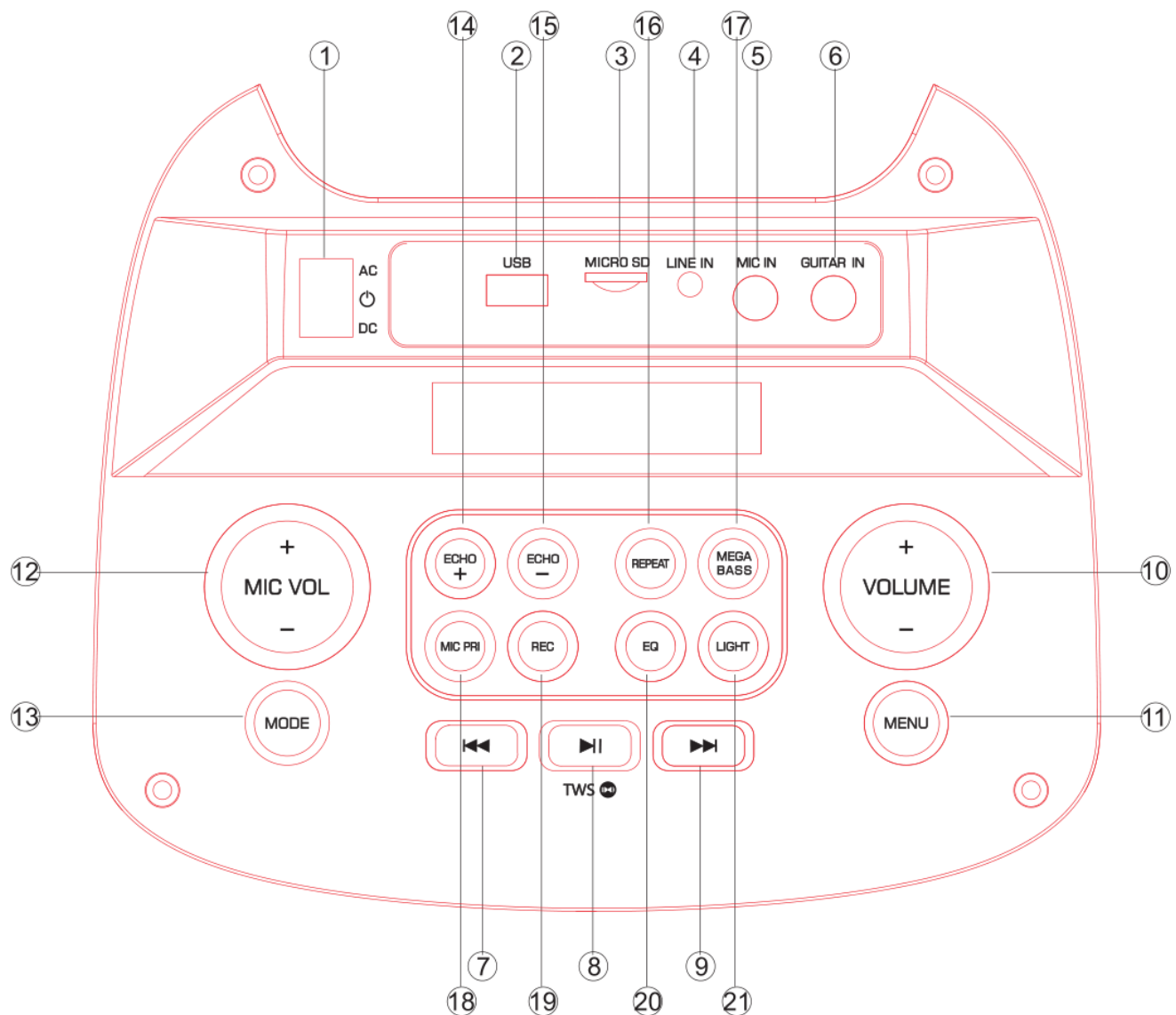

1. Power switch(AC play- Power off-DC play)
2. USB play back
3. Micro SD card play back
4. Aux-in (3.5mm PIN line cable)
5. MIC input
6. Guitar input
7. Short press for the previous song, long press for fast backward
8. Play/pause under USB/Micro SD/BT. Long press this button to enjoy TWS function.

TWS connection spec:

When you are playing a speaker (host) under USB/Micro SD/AUX/BT mode, at this time you want another speaker to share this song. You can turn on a new speaker, Long press "Play/pause" button, the LED display will show "SLAU" and keep blinking, now it is searching for the host. Once host found, this new speaker will connect automatically to the host, and "SLAU" will not blink. At this time 2pcs speakers are playing the same song.

The new joining speaker can operate: play/pause - previous song-next song- volume control

- 9 Next song: short press for next song, long press for fast forward.
- 10 Volume control: long press volume+/- to increase/decrease the LED light
- 11 MENU (control BASS/Treble/MIC Volume), long press this button to restore factory settings
- 12 Microphone volume control
- 13 Mode switch
- 14 Microphone Echo +
- 15 Microphone Echo –
- 16 REPEAT one song, Loop Playback.
- 17 Press to get super bass effect
- 18 Microphone priority (when playing USB/Micro SD, press this button, and the microphone volume will override songs in USB/Micro SD)
- 19 Short press to record songs from microphone to USB/Micro SD,;long press to play recordings, and long press again to delete recordings
- 20 EQ effect switch
- 21 Press to get various LED light effects, short press for color changing, long press and hold this button to change light modes. Or turn off the light. Press it again to turn on LED light.

Remote control

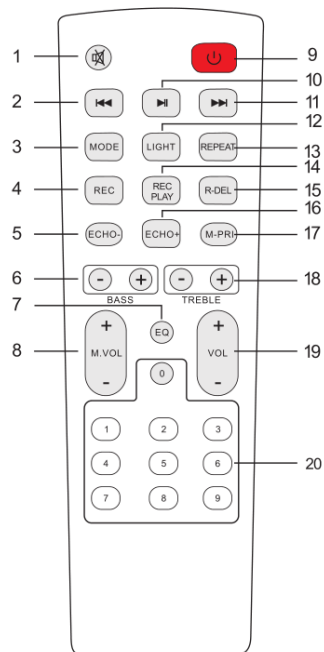

- 1. Mute**
Available to be mute at any mode
- 2. Previous Song**
Under USB/Micro SD card mode - previous song.
Under BT connection mode- previous song.
- 3. Mode**
Press short to skip to Wireless BT/LINE IN/USB/Micro SD mode.
- 4. Record function**
Under USB/Micro SD card mode, press "REC" button to record
- 5. Echo-**
- 6. BASS+/-**
- 7. EQ function**
- 8. Microphone Volume+/-**
- 9. Stand by**
- 10. Pause & Play**
- 11. Next song**
Under USB/Micro SD card mode - next song.
Under BT connection mode- next song.
- 12. Light mode control**
Short press to change light color, press and hold this button to change light mode, or off the light, press it again to turn the light on.
- 13. Repeat function**
- 14. Record play**
- 15. Record delete**
- 16. Echo+**
- 17. Microphone priority**

If you speak via microphone when playing music, your sound will override the sound in USB/Micro SD card

18. Treble+/-

19. Main Volume

20. Number buttons

Under USB/Micro SD mode to choose songs

OPERATING INSTRUCTIONS



- **Wireless BT Pairing Mode:**

Press MODE or the Blue button on the unit or the remote control until BT is selected.

1. Put the cell phone within 20 meters;

2. Activate the BT features on your cell phone so that the cell phone starts to search for BT device. Please refer to the user manual for details

3. Select the correct model no. **(BPS-455)**The device found by the cell phone;



4. Short press PLAY/PAUSE button  to play or pause music. Short press the  or  key to select the previous or next track.

- **LINE IN MODE:**

Press the MODE button on the unit or the remote control until the LINE is selected. Play the music of the device connected to the LINE input. Short press the  key to the next song

- **FM RADIO MODE:**

Press the MODE button on the unit or the remote control until FM is selected.

Press the  key and the speaker will auto search, then the speaker will read signal from 87.5MHz till 108MHz, if any frequency has signal, the unit will remember it and store it as a channel. After the searching is done, short press the  key to the previous channel and the  key to the next channel.

- **USB Mode:**

1. After start up, press MODE to select “USB” and insert the USB device. The unit will automatically read and play the music in the USB device.

2. Press the “⏸” key short to pause or play.

3. Short press the “⏮” key to the previous song.

4. Short press the “⏭” key to the next song.

Please notice - All products are subject to change without any notice. We take reservations for errors and omissions in the manual.

ALL RIGHTS RESERVED, COPYRIGHT DENVER ELECTRONICS A/S

DENVER®

www.denver-electronics.com



Electric and electronic equipment and included batteries contains materials, components and substances that can be hazardous to your health and the environment, if the waste material (discarded electric and electronic equipment and batteries) is not handled correctly.

Electric and electronic equipment and batteries is marked with the crossed out trash can symbol, seen above. This symbol signifies that electric and electronic equipment and batteries should not be disposed of with other household waste, but should be disposed of separately.

As the end user it is important that you submit your used batteries to the appropriate and designated facility. In this manner you make sure that the batteries are recycled in accordance with legislature and will not harm the environment.

All cities have established collection points, where electric and electronic equipment and batteries can either be submitted free of charge at recycling stations and other collection sites, or be collected from the households. Additional information is available at the technical department of your city.

Hereby, Inter Sales A/S declares that the radio equipment type BPS-455 is in compliance with Directive 2014/53/EU. The full text of the EU declaration of conformity is available at the following internet address: www.denver-electronics.com and then click the search ICON on topline of website. Write model number: BPS-455. Now enter product page, and RED directive is found under downloads/other downloads.

Operating Frequency Range: 2402MHz~2480MHz FM:87.5-108MHz

Max Output Power:72W

DENVER ELECTRONICS A/S

Omega 5A, Soeften

DK-8382 Hinnerup

Denmark

www.facebook.com/denverelectronics